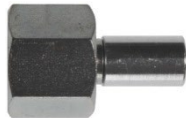
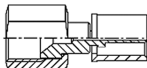
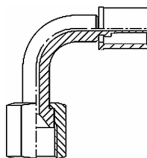

Koncovky pro hadice ZC-FR5-02 (DN2, 1/12") a ZC-FR5-04 (DN4, 5/32")

Koncovky pro hadici 1/12"	
	koncovky a objímky z mosazi

Koncovky pro hadici 5/32"	
	koncovky z pozinkované oceli, hliníková objímka

GW UNF, typ SAE, kužel 45°		
		
index	rozměr závitu [coul]	rozměr hadice [coul]
ZC-FR101-04-015	7/16-20 UNF (1/4 SAE)	1/12
ZC-FR101-04-025	7/16-20 UNF (1/4 SAE)	5/32
ZC-FR101-06-025	5/8-18 UNF (3/8 SAE)	5/32

GW UNF, typ SAE, kužel 45°		
		
index	rozměr závitu [coul]	rozměr hadice [coul]
ZC-FR102-04-015	7/16-20 UNF (1/4 SAE)	1/12
ZC-FR102-04-025	7/16-20 UNF (1/4 SAE)	5/32
ZC-FR102-06-025	5/8-18 UNF (3/8 SAE)	5/32

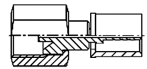
GW UNF, typ SAE, kužel 45°, se škrťicím ventilem		
		
index	rozměr závitu [coul]	rozměr hadice [coul]
ZC-FR103-04-015	7/16-20 UNF (1/4 SAE)	1/12

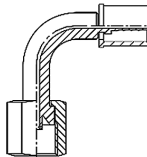
GW UNF, typ SAE, kužel 45°, se škrťicím ventilem		
		
index	rozměr závitu [coul]	rozměr hadice [coul]
ZC-FR104-04-015	7/16-20 UNF (1/4 SAE)	1/12

Škrťicí ventil do koncovky typu FR103 a FR104 (mosaz)		
		
index	rozměr závitu [coul]	rozměr hadice [coul]
ZC-FR103-D	-	-

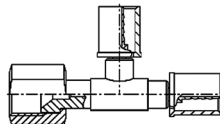
Adaptér – T- kus „L”, GW UNF, typ SAE, kužel 45°		
		
index	rozměr závitu [coul]	rozměr hadice [coul]
ZC-FR105-015	7/16-20 UNF (1/4 SAE)	1/12

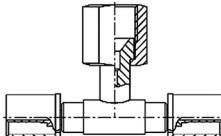
Adaptér – T-kus „T”, GW UNF, typ SAE, kužel 45°		
		
index	rozměr závitu [coul]	rozměr hadice [coul]
ZC-FR106-015	7/16-20 UNF (1/4 SAE)	1/12

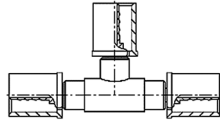
Adaptér – T-kus		
		
index	rozměr závitu [coul]	rozměr hadice [coul]
ZC-FR107-015	7/16-20 UNF (1/4 SAE)	1/12